

ISTRUZIONI DI MONTAGGIO - ASSEMBLING INSTRUCTIONS  
MONTAGEANLEITUNG - INSTRUCTIONS DE MONTAGE  
INSTRUCCIONES DE MONTAJE - ИНСТРУКЦИИ ПО МОНТАЖУ  
安装指导 - تعليمات التجميع

cattelan  
italia



# TERMINAL CONSOLLE

design Paolo Cattelan - 2019

Cattelan Italia spa si riserva di apportare, senza preavviso, modifiche nei materiali, nei rivestimenti, nelle finiture e nei disegni dei prodotti presentati in questo catalogo. Le textures ed i colori dei materiali e delle finiture hanno valore indicativo in quanto soggetti alle tolleranze dei processi di stampa.

Cattelan Italia spa reserves the right to change, without previous notice, materials, covers, finishes and drawings of the products presented in this catalogue. The textures and colours of materials and finishes are indicative as they are depending on the tolerances of the printing process.

Cattelan Italia spa behält sich vor, ohne Vorankündigung, Veränderungen an den Materialien, Bezügen, Finish und Zeichnungen der in diesem Katalog vorgestellten Produkte vorzunehmen. Die Texturen und Farben der Materialien und Finish haben einen hinweisenden Wert, da sie von den Toleranzen im Druckprozess abhängig sind.

Cattelan Italia spa se réserve le droit d'apporter, sans préavis, des modifications au niveau des matériaux, des revêtements, des finitions et du design des produits présentés dans ce catalogue. Les textures et les couleurs des matériaux et des finitions sont une valeur indicative parce-que ils changent selon la tolérance aux procédés d'imprimerie.

Cattelan Italia spa se reserva el derecho de aportar modificaciones de dibujo, materiales, acabados y tapicerías, sin que esté obligada a dar aviso anticipado. Las textures y los colores de los materiales y de los acabados tienen solo un valor indicativo porque están sujetos a la tolerancia en los procesos de imprenta.

Cattelan Italia spa оставляет за собой право делать изменения, без предупреждения, в материалах, обивках, отделках и в чертежах продуктов, которые представлены в данном каталоге. Текстуры и цвета материалов и отделки в каталоге не передают реальные цвета предметов, из-за особенностей процессов печати и цветопередачи.

Cattelan Italia 公司保留变更图册中材料、包覆材质、饰面、图像的权利，无须事先通知。因印刷等工艺存在偏差，材料和饰面等的纹理和颜色仅供参考。

**IMPORTANTE: Riporre per eventuali consultazioni future.**

**IMPORTANT: File for future consultation.**

**WICHTIG: Bitte aufbewahren für eventuelle spätere Nachfragen.**

**IMPORTANT: A conserver pour les futurs besoins de référence.**

**IMPORTANTE: Guardar para consultas posteriores.**

**ВАЖНО: Сохранить для возможной будущей консультации.**

**重要事项：存档以备日后咨询**

# TERMINAL CONSOLLE

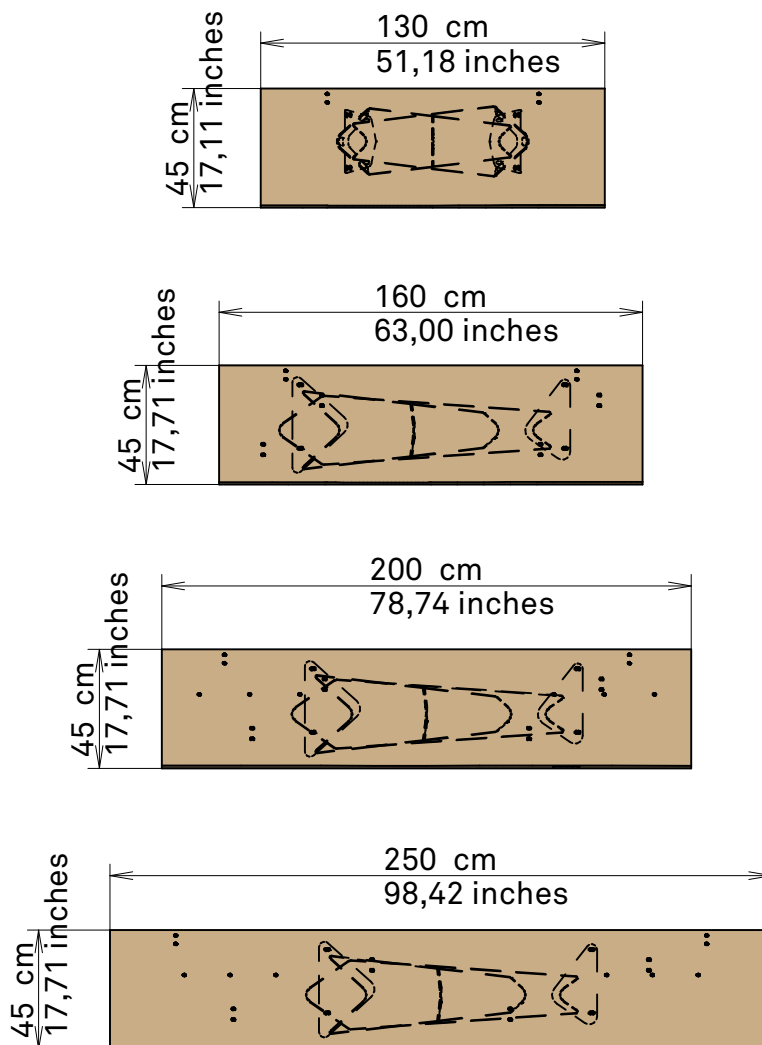
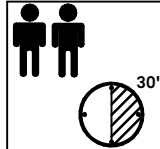

n° 04 TBCE M8x20 N.

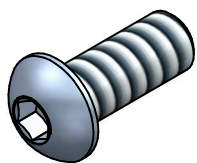

n° 04 rondella ø8x24 N.

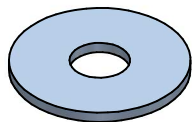

n° 04 TBCE M6x16 N.

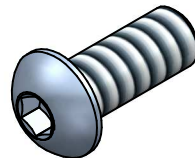

n° 06 rondella ø6x24 N.

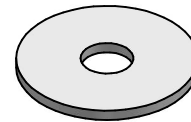

n° 02 cod. 215812000100.

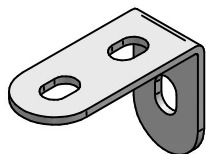

n° 02 MUNGO MN-S8x40.

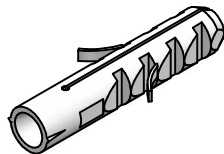

n° 02 TBCE M6x40 N.

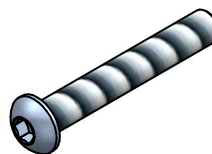

n° 02 pz 5 cm.

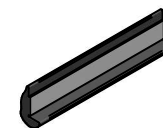

n° 02 pz 10 cm.

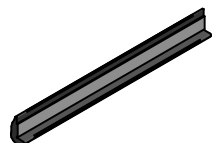

n° 04 pz 30x15 sp.3 mm.

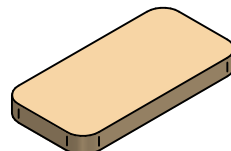

n° 01 da 04.

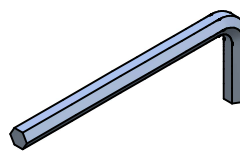

n° 01 da 05.

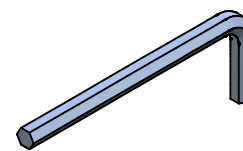

# TERMINAL CONSOLLE KERAMIK PREMIUM

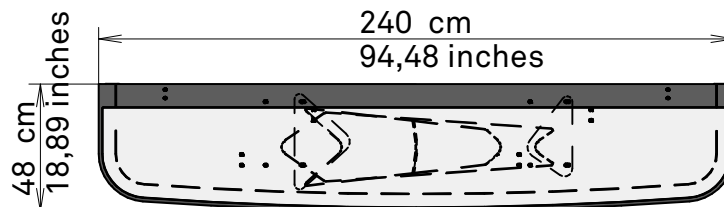
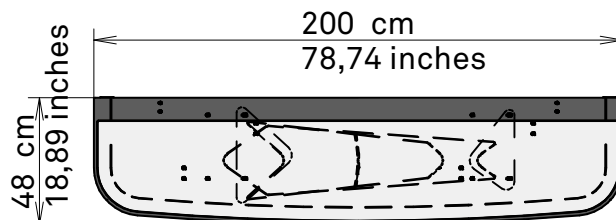
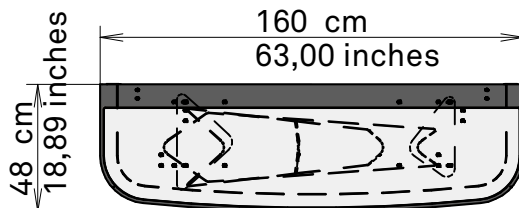
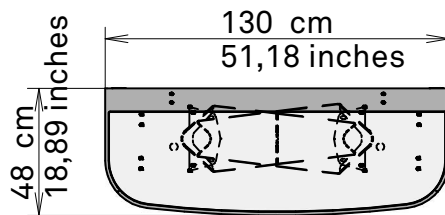

n° 04 TBCE M8x20 N.

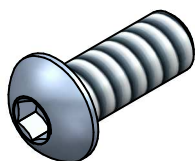

n° 04 rondella ø8x24 N.

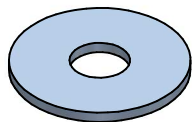

n° 04 TBCE M6x16 N.

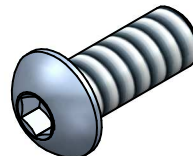

n° 06 rondella ø6x24 N.

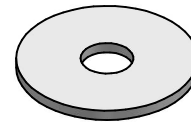

n° 02 cod. 215812000100.

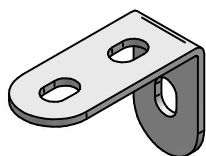

n° 02 MUNGO MN-S8x40.

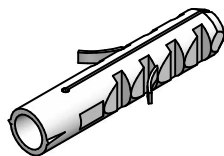

n° 02 TBCE M6x40 N.

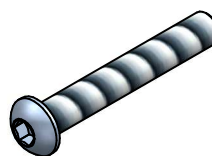

n° 02 pz 5 cm.

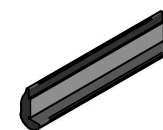

n° 02 pz 10 cm.

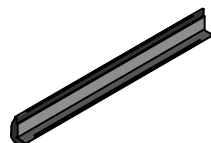

n° 04 pz 30x15 sp.3 mm.

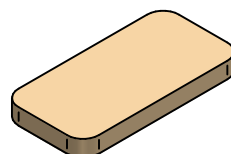

n° 01 da 04.

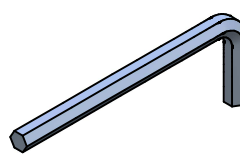

n° 01 da 05.

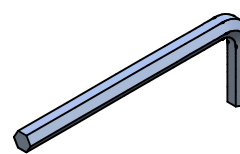



# TERMINAL CONSOLLE WOOD-C

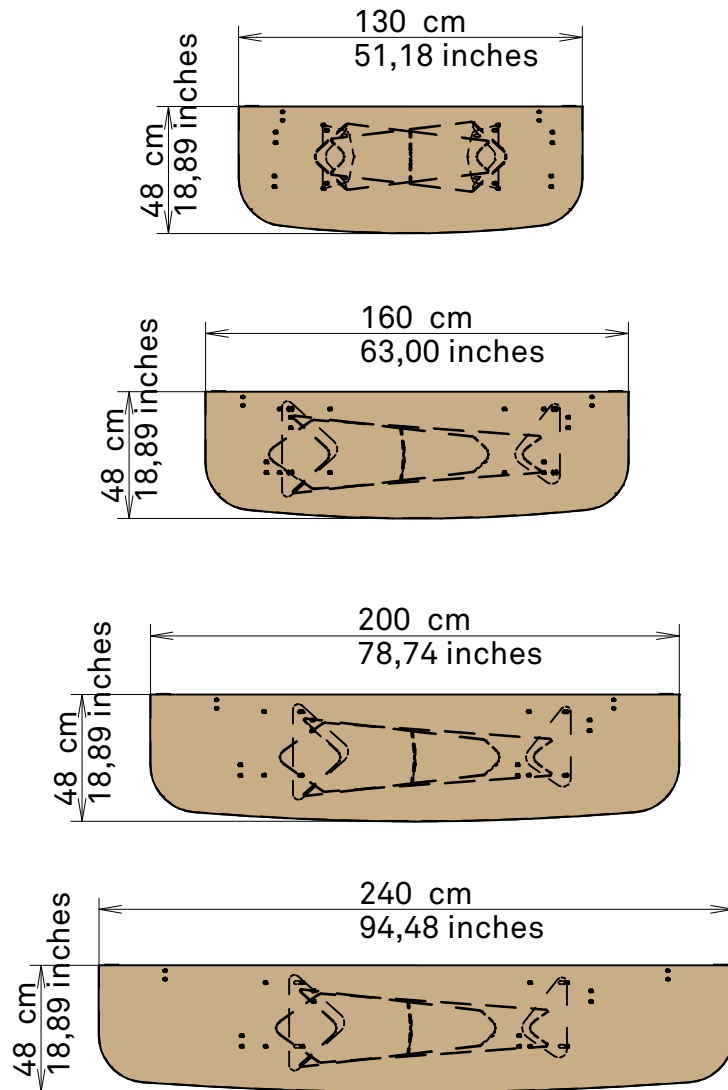
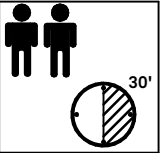

n° 04 TBCE M8x20 N.

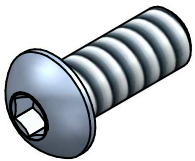

n° 04 rondella ø8x24 N.

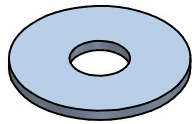

n° 04 TBCE M6x16 N.

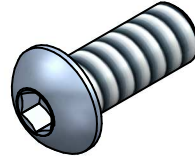

n° 06 rondella ø6x24 N.

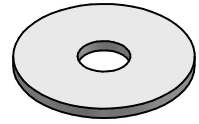

n° 02 cod. 215812000100.

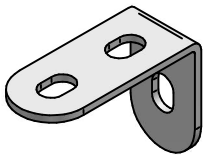

n° 02 MUNGO MN-S8x40.

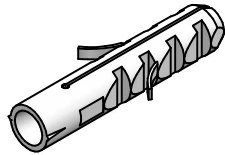

n° 02 TBCE M6x40 N.

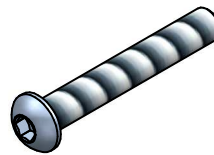

n° 02 pz 5 cm.

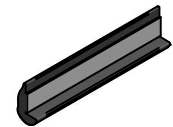

n° 02 pz 10 cm.

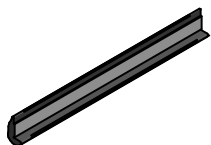

n° 04 pz 30x15 sp.3 mm.

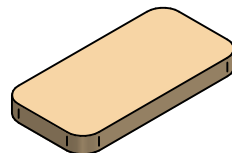

n° 01 da 04.

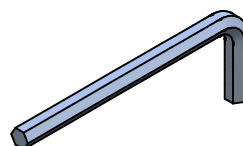

n° 01 da 05.

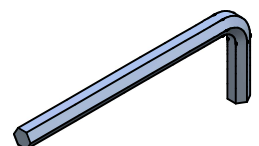

# TERMINAL CONSOLLE

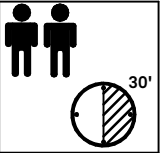

## Terminal consolle

130x45 cm — 51,18x17,11 inch

## Terminal consolle Keramik Premium

130x48 cm — 51,18x18,89 inch

## Terminal concolle Wood-C

130x48 cm — 51,18x18,89 inch

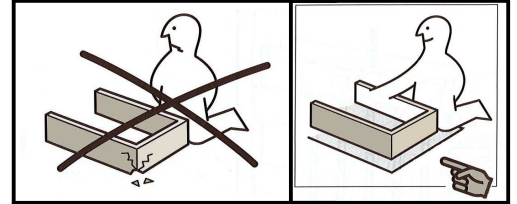

**IMPORTANTE! - VERY IMPORTANT!**  
**WICHTIG! - TRÈS IMPORTANT!**  
**¡MUY IMPORTANTE! - ВАЖНО - 警告**

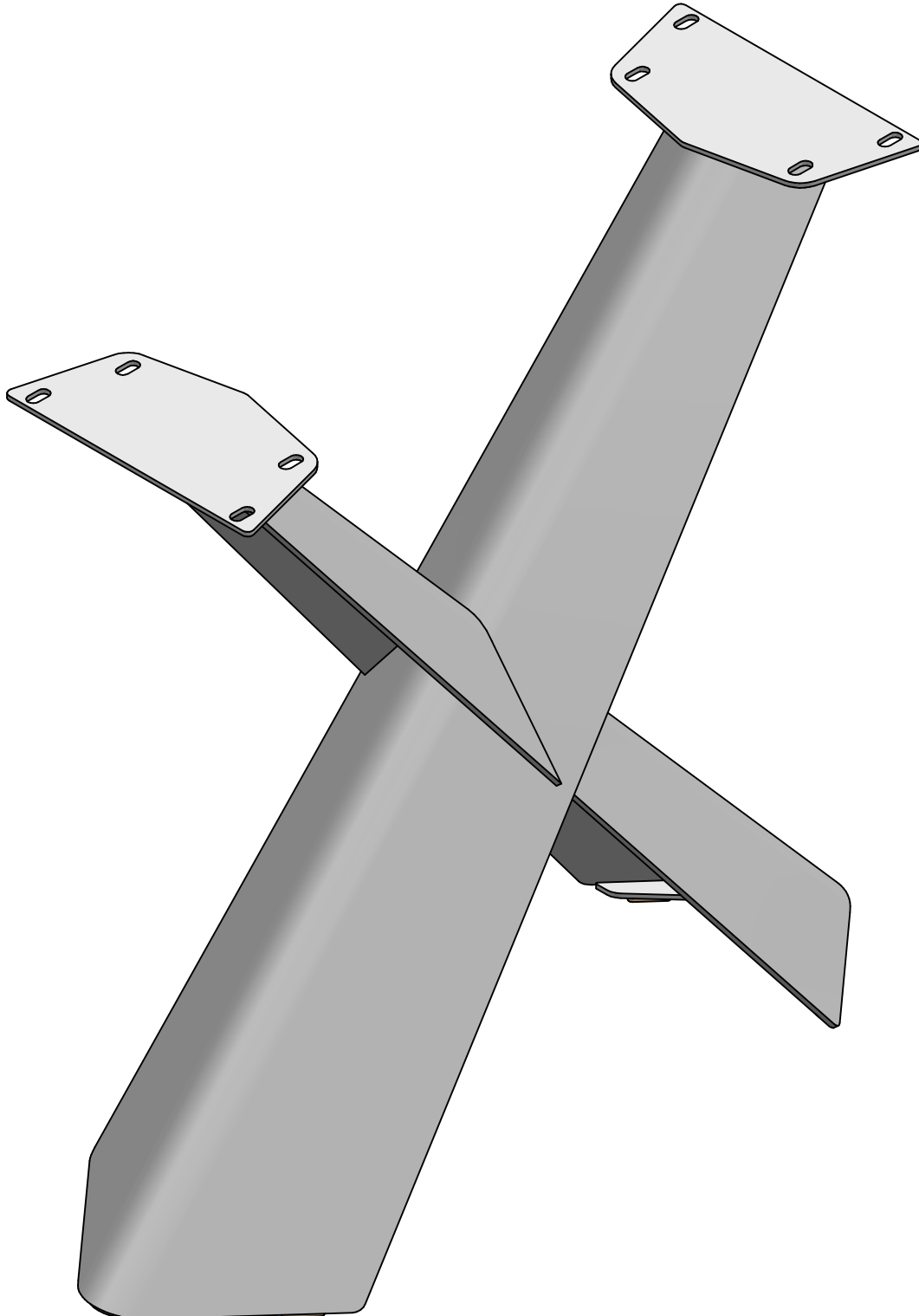

# TERMINAL CONSOLLE

## Terminal consolle

- 160x45 cm — 63,00x17,71 inch
- 200x45 cm — 78,74x17,71 inch
- 250x45 cm — 98,42x17,71 inch

## Terminal consolle Keramik Premium

- 160x48 cm — 63,00x18,89 inch
- 200x48 cm — 78,74x18,89 inch
- 240x48 cm — 94,48x18,89 inch

## Terminal consolle Wood-C

- 160x48 cm — 63,00x18,89 inch
- 200x48 cm — 78,74x18,89 inch
- 240x48 cm — 94,48x18,89 inch

**IMPORTANTE! - VERY IMPORTANT!**  
**WICHTIG! - TRÈS IMPORTANT!**  
**¡MUY IMPORTANTE! - ВАЖНО - 警告**

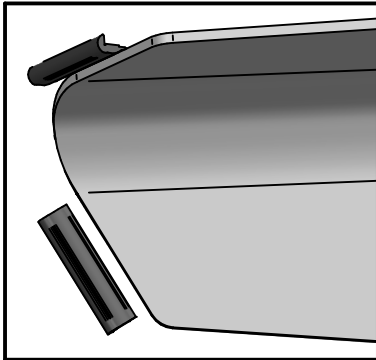

**ESSENZIALE!**  
**ESSENTIAL!**  
**NOTWENDIG!**  
**ESSENTIEL!**  
**¡ESENCIAL!**

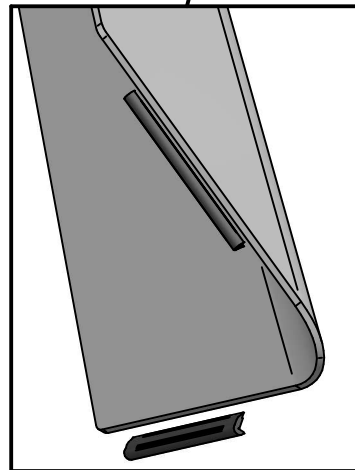
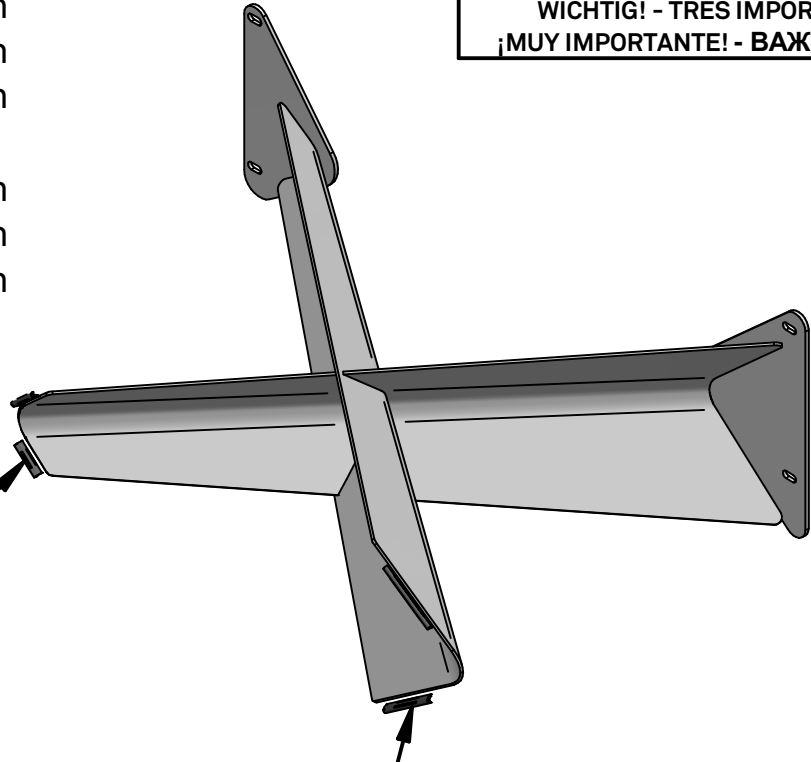

**ESSENZIALE!**  
**ESSENTIAL!**  
**NOTWENDIG!**  
**ESSENTIEL!**  
**¡ESENCIAL!**

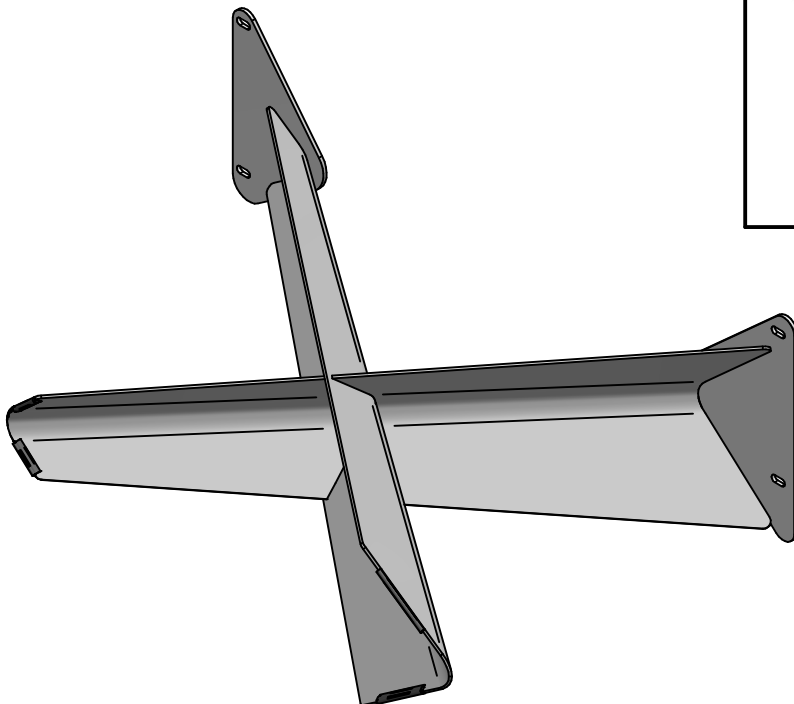

n° 02 pz 5 cm.

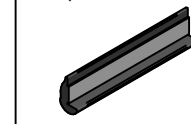

n° 02 pz 10 cm.

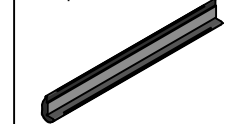

# TERMINAL CONSOLLE

## Terminal consolle

130x45 cm — 51,18x17,11 inch

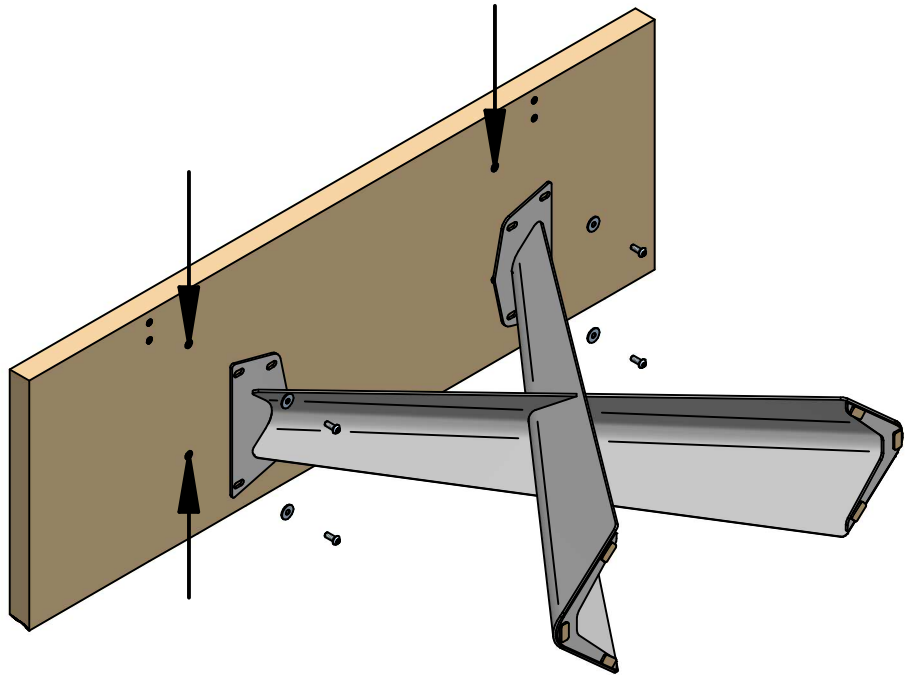
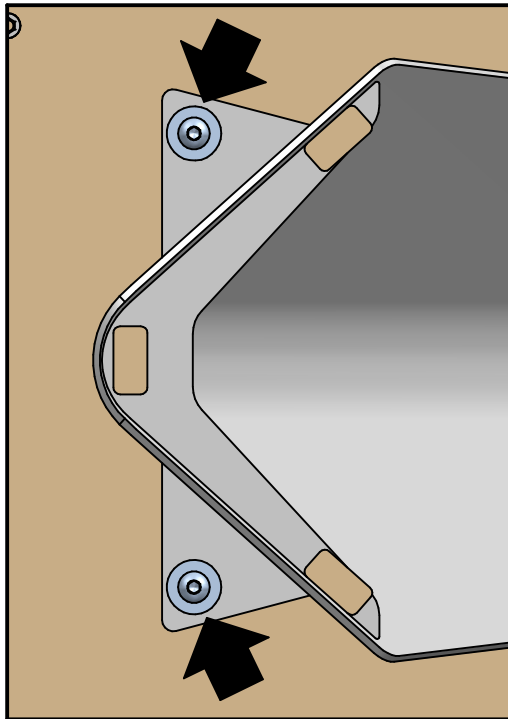

n° 04 TBCE M8x20 N.



n° 04 rondella ø8x24 N.

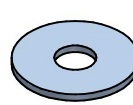

n° 01 da 5.



## Terminal consolle Keramik Premium

130x48 cm — 51,18x18,89 inch

## Terminal consolle Wood-C

130x48 cm — 51,18x18,89 inch

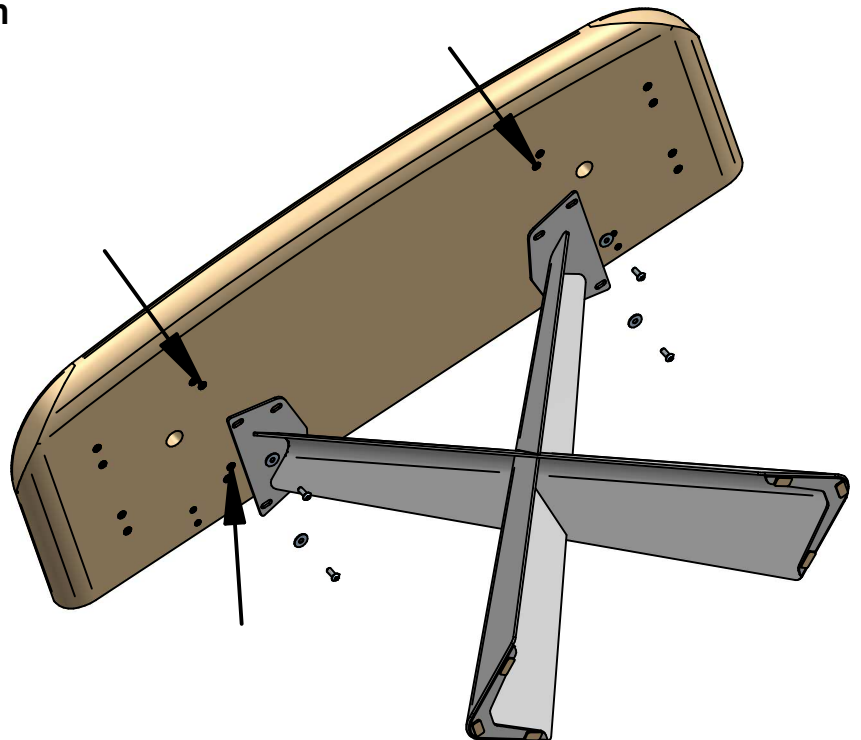
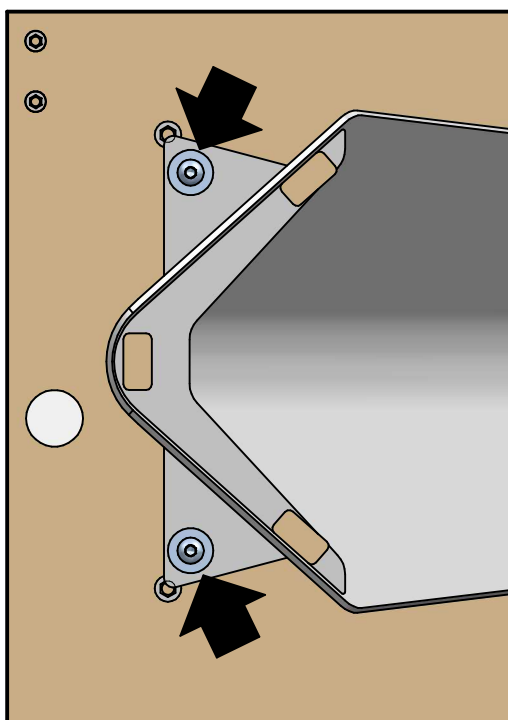

n° 04 TBCE M8x20 N.



n° 04 rondella ø8x24 N.

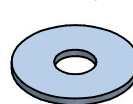

n° 01 da 5.





# TERMINAL CONSOLLE

## Terminal consolle

160x45 cm — 63,00x17,71 inch  
200x45 cm — 78,74x17,71 inch  
250x45 cm — 98,42x17,71 inch

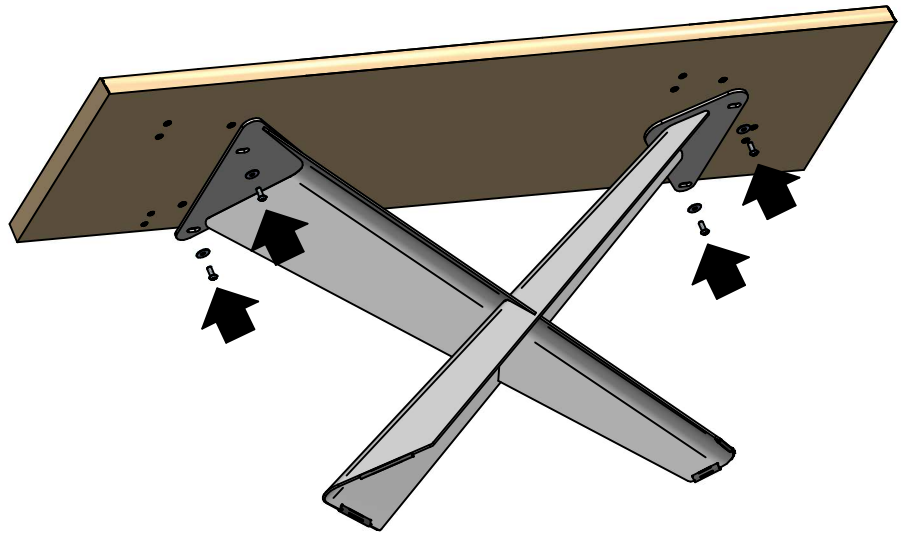

160x45 cm — 63,00x17,71 inch

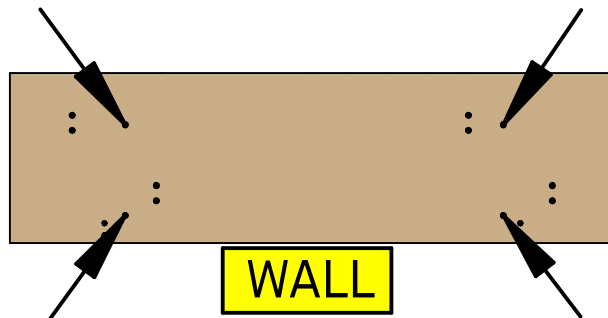

200x45 cm — 78,74x17,71 inch

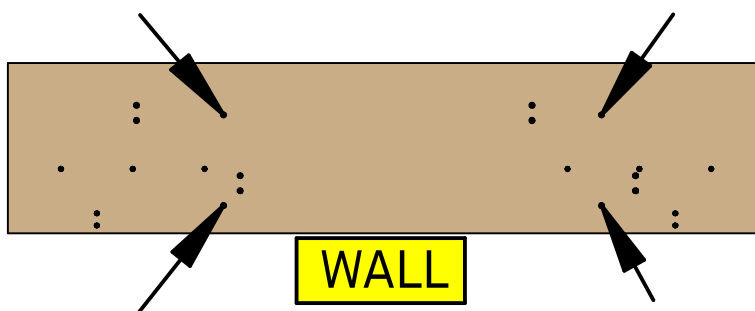

250x45 cm — 98,42x17,71 inch

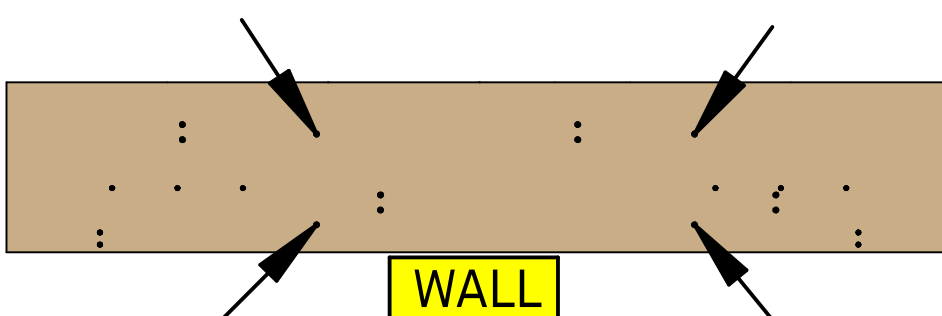

n° 04 TBCE M8x20 N.



n° 04 rondella ø8x24 N.

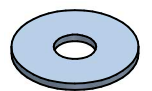

n° 01 da 5.



# TERMINAL CONSOLLE

## Terminal consolle Keramik Premium

160x48 cm — 63,00x18,89 inch

200x48 cm — 78,74x18,89 inch

240x48 cm — 94,48x18,89 inch

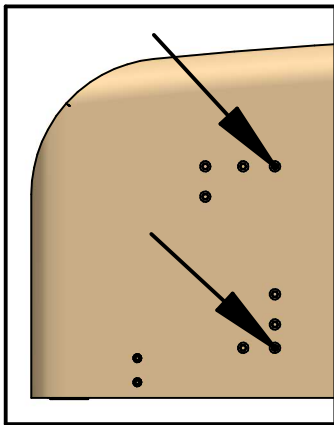
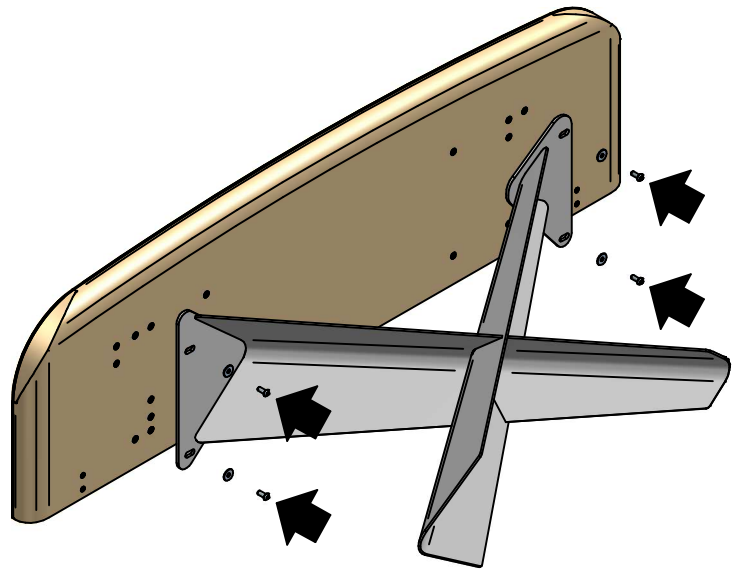

160x48 cm — 63,00x18,89 inch

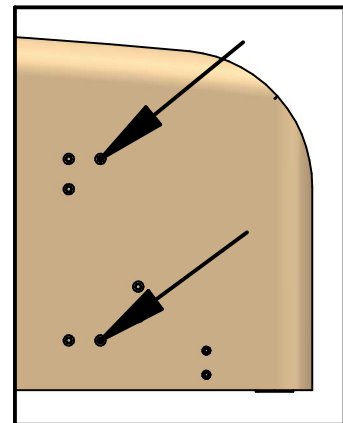
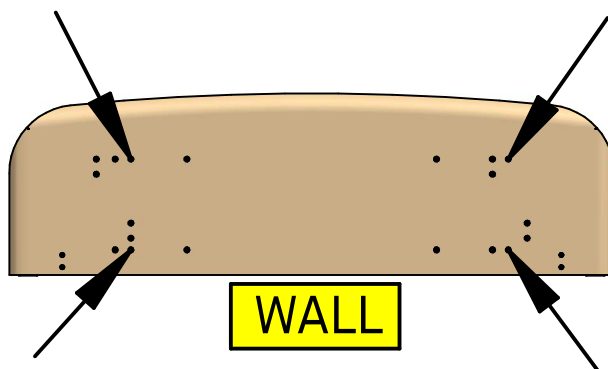

200x48 cm — 78,74x18,89 inch

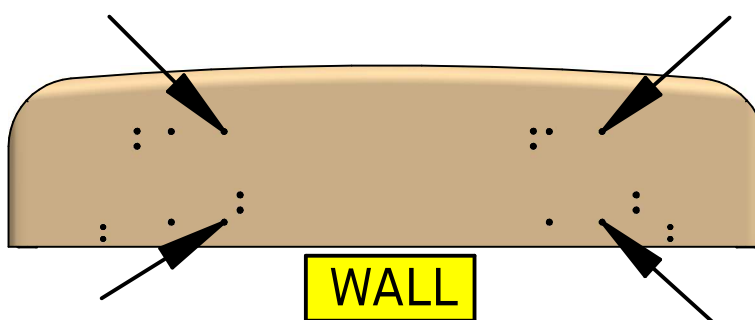

240x48 cm — 94,48x18,89 inch

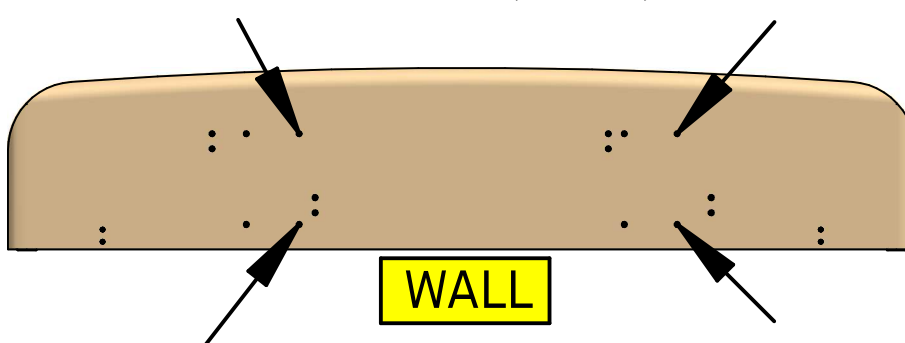

n° 04 TBCE M8x20 N.



n° 04 rondella ø8x24 N.

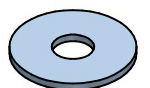

n° 01 da 5.



# TERMINAL CONSOLLE

## Terminal concolle Wood-C

160x48 cm — 63,00x18,89 inch

200x48 cm — 78,74x18,89 inch

240x48 cm — 94,48x18,89 inch

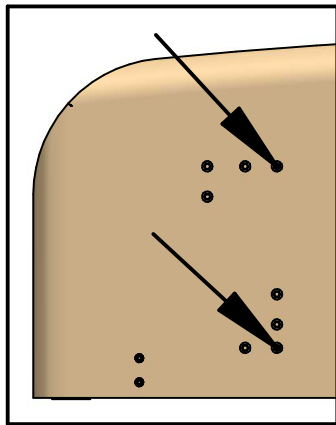
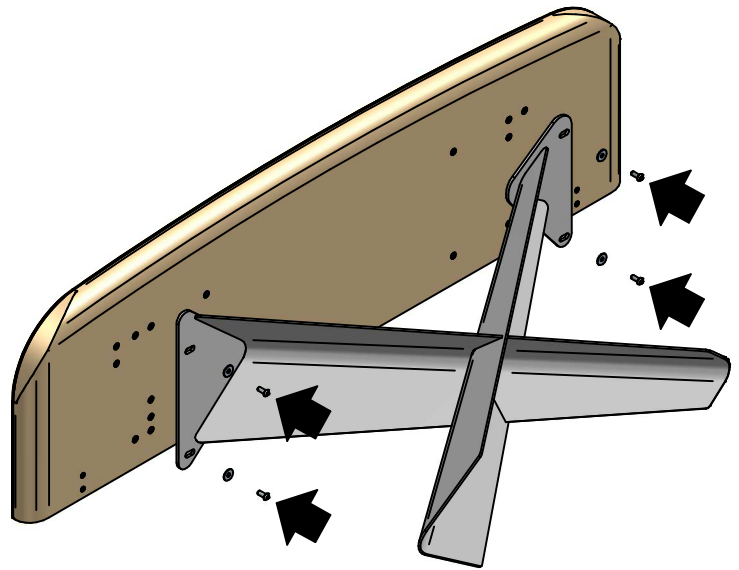

160x48 cm — 63,00x18,89 inch

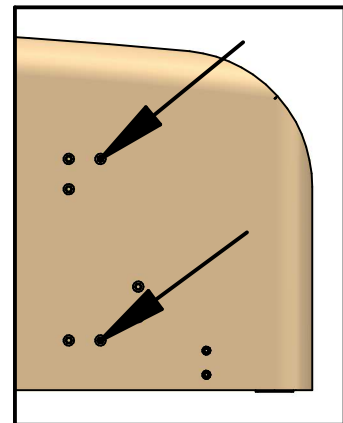
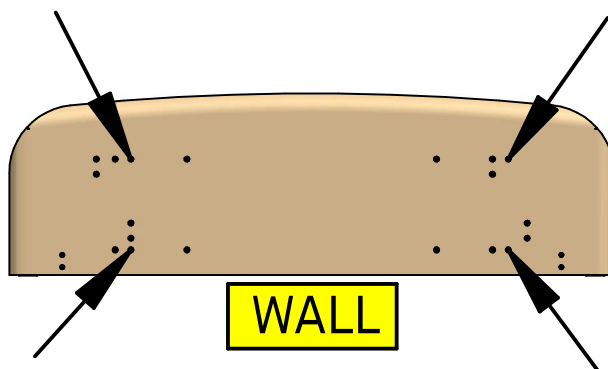

200x48 cm — 78,74x18,89 inch

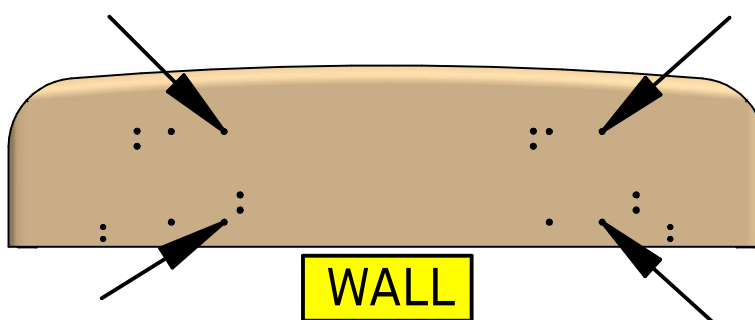

240x48 cm — 94,48x18,89 inch

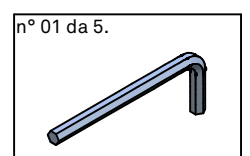
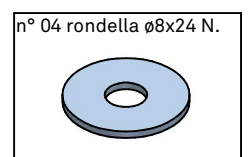
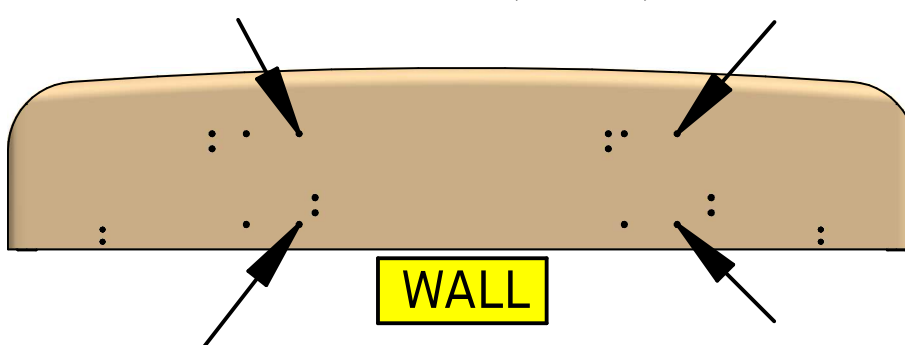

# TERMINAL CONSOLLE

Terminal consolle  
 Terminal consolle Keramik Premium  
 Terminal consolle Wood-C

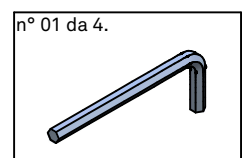
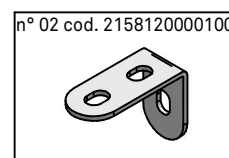
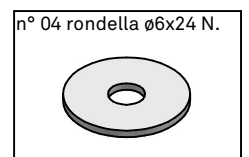
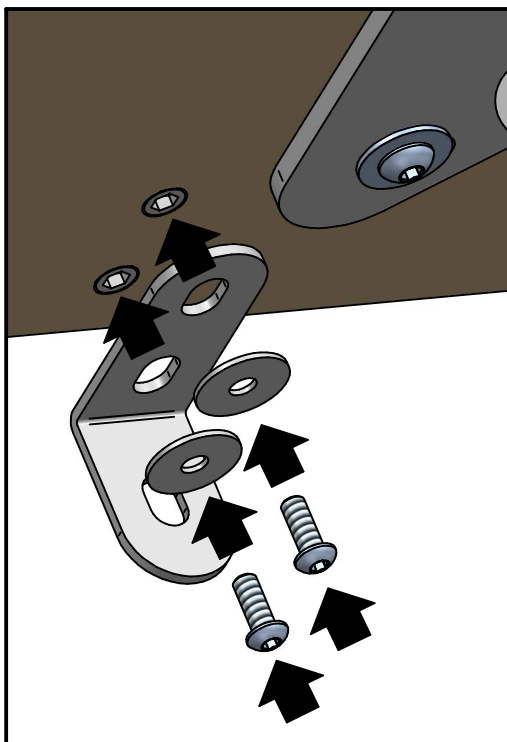
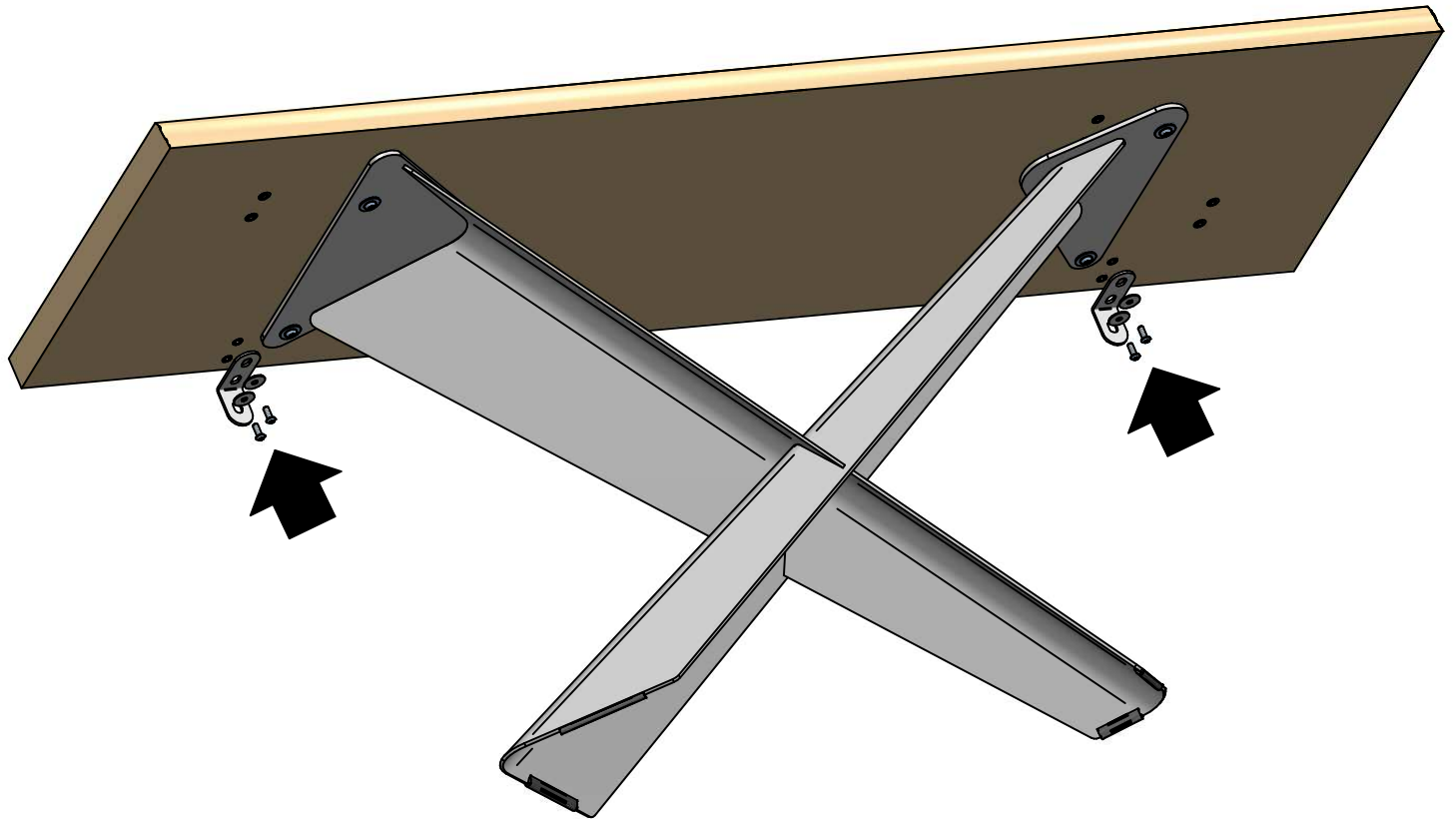

# TERMINAL CONSOLLE



Terminal consolle  
Terminal consolle Keramik Premium  
Terminal consolle Wood-C

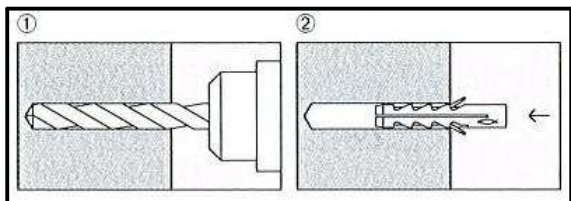
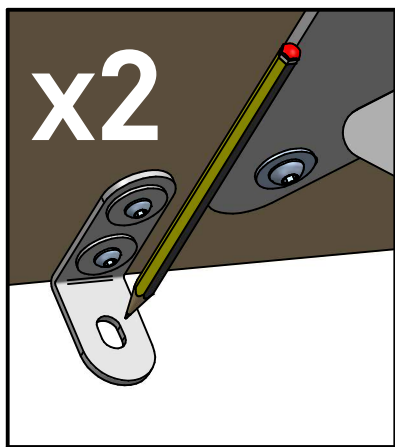

Foro  $\varnothing 8$  mm  
Hole  $\varnothing 0,31$  inches

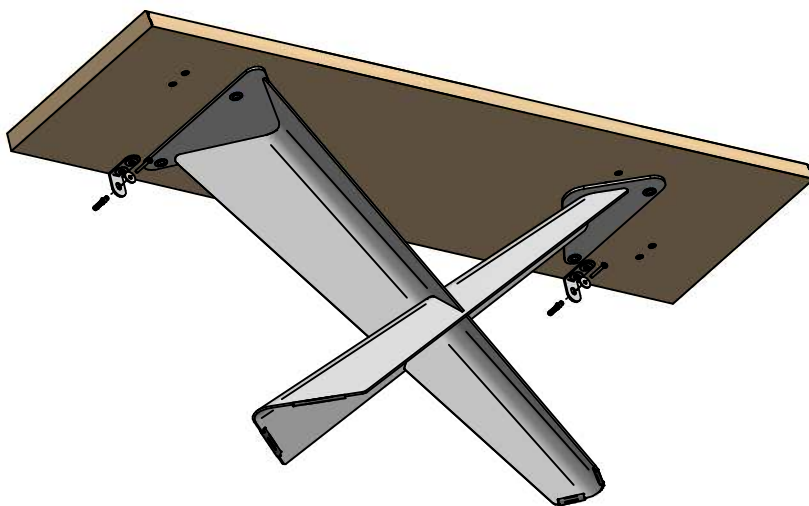

ESSENZIALE!  
ESSENTIAL!  
NOTWENDIG!  
ESSENTIEL!  
¡ESENCIAL!



x2

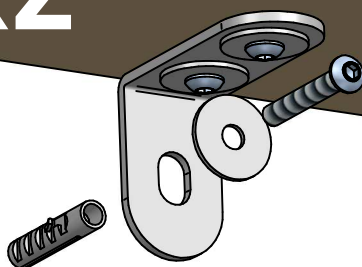

n° 02 TBCE M6x40 N.



n° 02 rondella  $\varnothing 6 \times 24$  N.

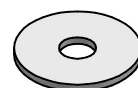

n° 02 MUNGO MN-S8x40.

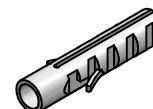

n° 01 da 4.







## **AVVERTENZE PER IL CLIENTE FINALE**



### **USO**

Il prodotto é destinato per l'utilizzo all'interno delle abitazioni con l'uso per il quale é stato realizzato.



### **MANUTENZIONE**

Non vanno assolutamente utilizzati strumenti metallici appuntiti o panni abrasivi per eliminare eventuali residui di sporco presenti sulla superficie del prodotto, in quanto possono danneggiare la superficie stessa. Non vanno assolutamente utilizzati detergenti che contengano cloro o a base di acido cloridrico, acido muriatico o prodotti anticalcare in quanto andrebbero ad alterare la brillantezza del prodotto.

### **MANUTENZIONE LEGNO**

Il legno é un materiale vivo e come tale può avere mutamenti nel tempo di colore e di dimensione, gli oggetti che vengono appoggiati sul piano, devono essere spostati periodicamente poiché il legno è sensibile alla luce e si ossida, creando differenze di colore tra le parti esposte alla luce e quelle coperte. Per la normale pulizia utilizzare un panno morbido leggermente umido. Non usare detersivi abrasivi, solventi, ammoniaci, acetone o petrolio. Per la rimozione di macchie utilizzare una soluzione di acqua e sapone neutro, avendo l'accortezza di asciugare subito le superfici bagnate.

### **ATTENZIONE**

Non spostare assolutamente mai il prodotto trascinandolo o sollevandolo prendendolo per il piano ma smontarlo e riposizionarlo dove voluto, assicurandosi di proteggere le parti che si potrebbero danneggiare.

### **SMALTIMENTO**

Una volta dismesso, il prodotto od i suoi componenti non vanno dispersi nell'ambiente ma conferiti ai sistemi pubblici di smaltimento.



## **INSTRUCTIONS FOR THE END CUSTOMER**



### **USE**

The product is intended to be used in the inside and for the purposes it was created for.



### **MAINTENANCE**

It is recommended not to use metal sharp tools or abrasive clothes to eliminate dirt from the surface, because they could damage the same. Do not absolutely use detergents containing chlorine, muriatic acid, hydrochloric acid or descale detergents which can damage the surface brilliance.

### **MAINTENANCE WOOD**

Wood is a living material and therefore susceptible to slight colour and dimension changes. As the wood is sensitive to light and oxidizes, any item standing in the same place on the top for a long period of time can create colour differences between the covered and the exposed parts, so they should be moved periodically. Clean it with a slightly damp soft cloth. DO NOT use any chemicals or harsh detergents such as ammonia. To remove stains, wash the top with mild soap and water, and rinse. Dry the top thoroughly.

### **WARNING**

Do not absolutely move the product dragging it or lifting it by gripping the top, but disassemble it and then place it in the new site, protecting the parts that could be damaged.

### **DISPOSAL**

Once discarded, neither the product nor its components should be dispersed in the environment, but rather consigned to public disposal systems.



## **HINWEISE FÜR DEN ENDKUNDEN**



### **NUTZUNG**

Das Produkt ist nur für den Innenbereich gedacht. Der Tisch wurde hergestellt, nur als Esstisch genutzt zu werden.



### **WARTUNG**

Niemals scharfe Werkzeuge aus Metall, spitzen Instrumente oder Schleifmittel für die Reinigung der Oberfläche verwenden. Diese Produkte können die Oberfläche beschädigen. Niemals Chemikalien mit chlorhaltigen Salzsäure, Salzsäure oder Kalk-Produkte für die Reinigung verwenden. Diese Produkte können der Glanz beschädigen.

### **PFLEGE DES HOLZES**

Holz ist ein lebendes Material und kann sich in der Farbe und Größe ändern. Objekte, die auf die Platte gestellt werden, müssen periodisch bewegt werden, da Holz lichtempfindlich ist und oxidiert und dadurch die Farbe ändert. Für die normale Reinigung genügt ein weiches, feuchtes Tuch. Bitte kein Scheuermittel, Lösungsmittel, Ammoniak, Aceton oder Öl verwenden. Zum Entfernen von Flecken milde Seife und Wasser benutzen, die nassen Oberflächen sofort abtrocknen.

### **ACHTUNG**

Der Tisch absolut nie ziehen oder heben. Falls der Tisch soll bewegt werden, muss zerlegt werden und sorgfältig in der neue Stelle positioniert. Die empfindliche Teile sollen geschützt werden.

### **ENTSORGUNG**

Nach der Aussonderung ist das Produkt und seine Bestandteile nicht selbständig im Freien zu entsorgen, sondern der städtischen Müllabfuhr zu übergeben.



## **INSTRUCTIONS POUR LE CLIENT FINAL**



### **UTILISATION**

Le produit est destiné pour une utilisation à l'intérieur des habitations.



### **MANUTENTION**

Il ne faut pas absolument utiliser des outils pointus ou des chiffons abrasifs pour éliminer des possibles restes sur la surface du produit, parce qu'ils peuvent endommager la surface même. Ne pas utiliser des détergents contenant du chlore, acide chlorhydrique, acide muriatique ou produits anticalcaire qui peuvent altérer le brillant du produit.

### **ENTRETIEN BOIS**

Le bois est une matière qui vit, et comme tel il peut avoir des changements de couleur, de dimension, les objets posés sur le plateau doivent être posés de façon intermittente car la sensibilité à la lumière peut créer des différences de ton entre les parties du plateau couverte ou non par les objets. Pour l'entretien, utilisez un chiffon doux et légèrement humide. Ne pas utiliser de revêtements abrasifs, ammoniacal ou autre détergeant. Pour enlever les taches utiliser de l'eau et du savon neutre, en essuyant immédiatement les parties concernées.

### **ATTENTION**

Ne pas absolument déplacer le produit en le traînant ou en le soulevant par le top, mais démontez-le et positionnez-le autre part, en s'assurant de protéger les parties qui pourraient s'endommager.

### **ECOULEMENT**

Une fois déposé, le produit ou ses composants ne doivent pas être dispersés dans la nature mais confiés aux décharges publiques.



## **INSTRUCCIONES PARA EL CLIENTE FINAL**



### **USO**

El producto está destinado para su uso dentro del hogar, a los fines por los cuales fue creado.



### **MANTENIMIENTO**

No utilizar en cualquier forma instrumentos de metal afilados o telas abrasivas para eliminar cualquier resto de suciedad en la superficie del producto, ya que pueden dañar la superficie misma. No utilizar en cualquier forma limpiadores a base de cloro o que contienen ácido clorhídrico, ácido muriático o productos anticalcáreos ya que pueden alterar el brillo del producto.

### **MANTENIMIENTO MADERA**

La madera es un material vivo y, como tal, puede tener cambios con el tiempo de color y tamaño, los objetos que se colocan en el sobre, se deben mover periódicamente ya que la madera es sensible a la luz y se oxida, creando diferencias de color entre las piezas expuestas a la luz y las cubiertas. Para la limpieza normal, use un paño suave ligeramente humedecido. No use limpiadores abrasivos, disolventes, amoniacal, acetona y aceite. Para quitar las manchas utilizar una solución de jabón suave y agua, asegurándose de secar las superficies mojadas inmediatamente.

### **ATENCIÓN**

No muevan absolutamente nunca el producto arrastrándolo o mediante el levantamiento del plano, sino desmontarlo y llevarlo a donde querían, asegurándose de proteger las partes que pueden dañarse.

### **ELIMINACIÓN DE DESECHOS**

Una vez desechado, el producto o sus componentes no se tienen que abandonar en el entorno sino entregar al sistema público de recogida de basuras.



**cattelan  
italia**

**CATTELANITALIA.COM**



**CATTELAN ITALIA SPA** – via pilastri 19 – 36010 Carré / Vicenza – Italy  
phone +39 0445 318711 - fax +39 0445 314289 - email: [info@cattelanitalia.com](mailto:info@cattelanitalia.com)