

VEGA INOX-WOOD

ISTRUZIONI DI MONTAGGIO
ASSEMBLING INSTRUCTIONS
INSTRUCTIONS DE MONTAGE
INSTRUCCIONES DE MONTAJE
MONTAGEANLEITUNG

cattelan
italia
Cattelan Italia S.p.A. - 38010 - Carrè - VI - Italy
tel +39 0445 318711 - fax +39 0445 314289
info@cattelanitalia.com

1

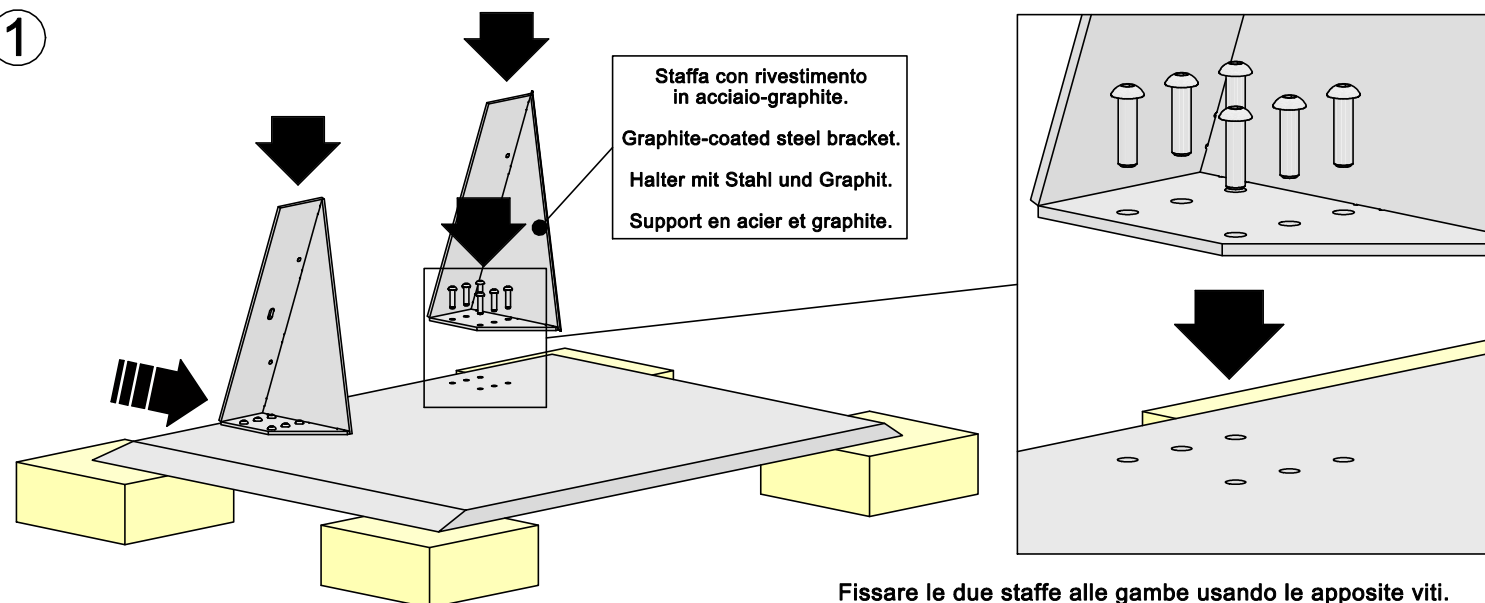

Staffa con rivestimento
in acciaio-graphite.
Graphite-coated steel bracket.
Halter mit Stahl und Graphit.
Support en acier et graphite.

Fissare le due staffe alle gambe usando le apposite viti.
IMPORTANTE: FISSARE LE DUE STAFFE ASSOLUTAMENTE VERSO IL BASSO!!!!

Fix both frames to the legs using the provided screws.
IMPORTANT : FIX THE TWO FRAMES DOWNWARD!!!!

Die zwei Bügel, durch die dazugehörige Schrauben mit den Beine bitte befestigen.
WICHTIG: DIE ZWEI BUEGEL UNBEDINGT HINAB BEFESTIGEN!!!!

Fixer les deux pattes aux pieds avec les vis en dotation.
TRES IMPORTANT: IL FAUT ABSOLUMENT FIXER LES PATTES AVERS LES BAS!!!!

N° 24 TBCE M8x25 N.

N° 01 da 5.

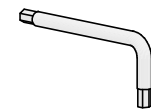
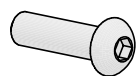

2

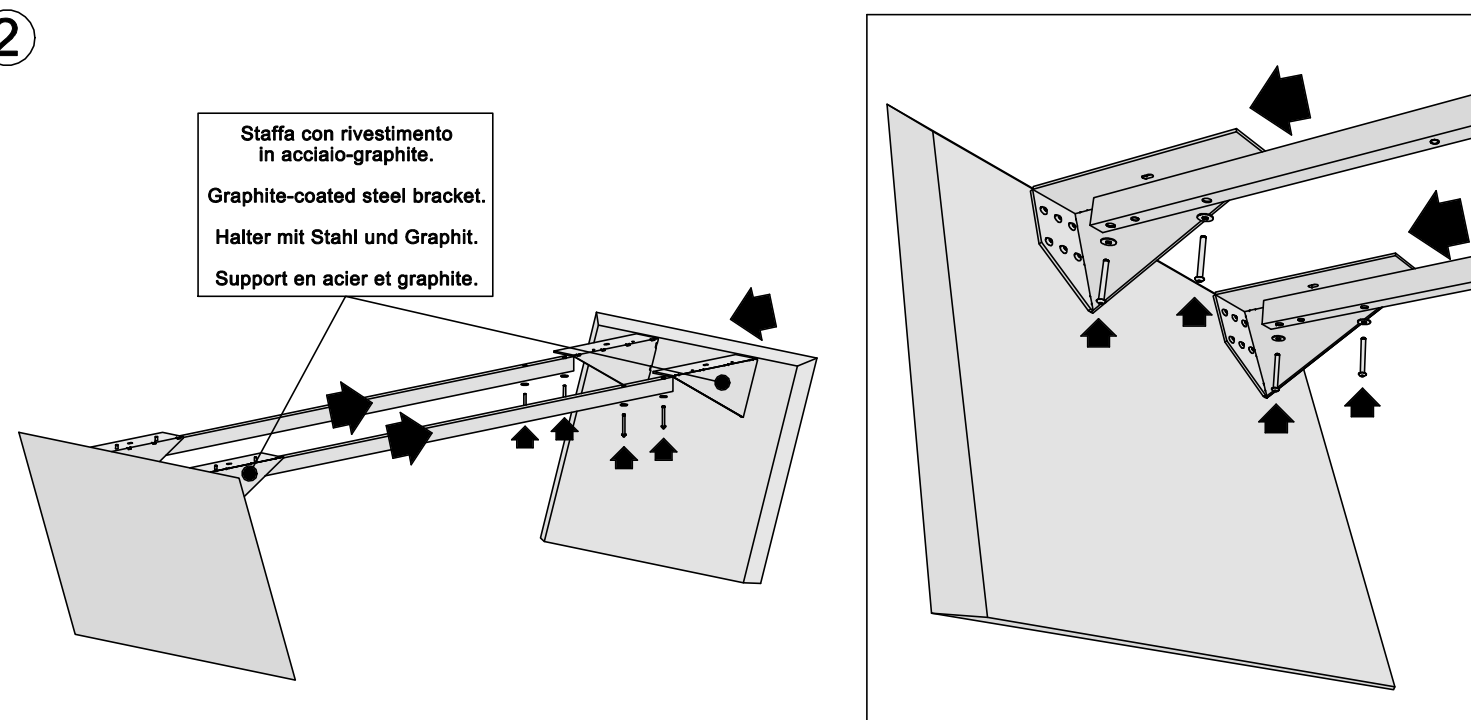

Staffa con rivestimento
in acciaio-graphite.
Graphite-coated steel bracket.
Halter mit Stahl und Graphit.
Support en acier et graphite.

Pre-montare le due gambe alle due traverse.

Pre-assemble the two legs to the two traverses.

Bügel Edelstahl verkleidet Vorher die zwei Beinemit den zwei Querträger bitte befestigen.

Il faut monter à l'avance les deux jambes aux traverses.

N° 08 TBCE M8x60 N.

N° 08 ø 8x24 N.

N° 01 da 5.

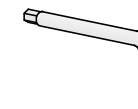
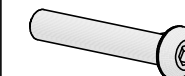

3

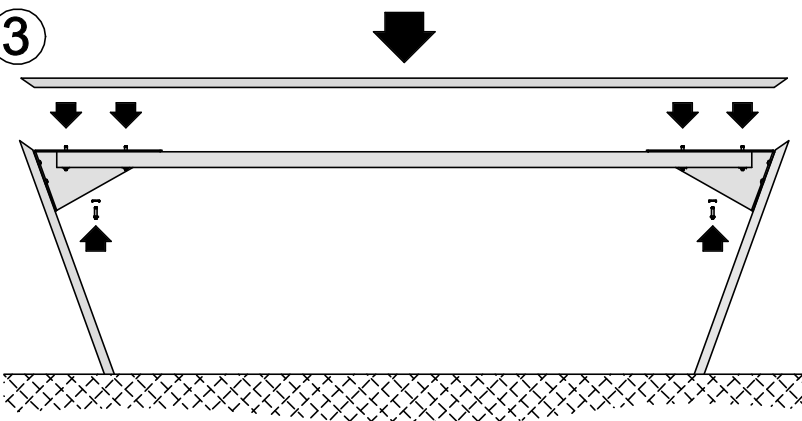

IMPORTANT!!!!

ATTENZIONE: PRIMA DI ASSEMBLARE IL PIANO CONTROLLARE IL VERSO DELLE FORATURE (VEDI PARTICOLARE) !!!!!

IMPORTANT: BEFORE ASSEMBLING THE TOP CHECK THE DIRECTION OF THE HOLES (SEE THE DETAILED DRAWING)!!!!

ACHTUNG: VOR DIE MONTAGE DER PLATTE, DIE RICHTUNG DEN BOEHRUNGEN UEBERPRUEFEN. (SKIZZE BEACHTEN).

ATTENTION : AVANT DE MONTER LE PLATEAU IL FAUT VERIFIER LE SENS DES PERCAGES. (VOIR DETAIL)!!!!

N° 04 TBCE M8x25 N.

N° 04 ø 8x24 N.

N° 01 da 5.

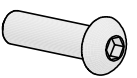

4

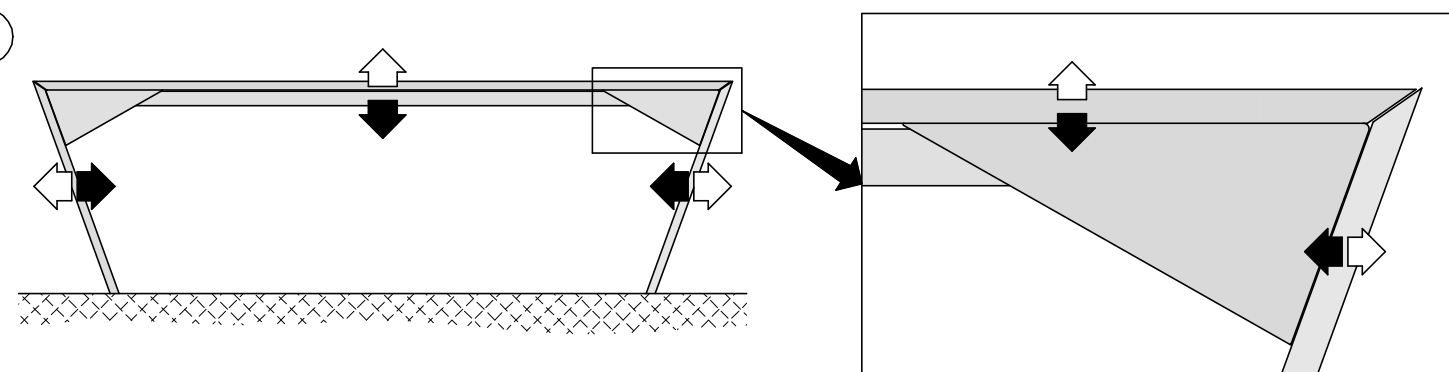

Per allineare il piano allentare le viti indicate nel particolare **A** , quindi assestare il piano rispetto alle gambe e rifissare le viti.

To level the top loosen the screws indicated on the picture **A** , then settle the top on the legs and fix the screws again.

Für die Anreihung der Platte, die Schrauben laut Skizze **A** nachlassen, die Platte anpassen und die Schrauben wieder befestigen.

Pour l'alignement du plateau il faut d'abord desserrer les vis du point **A** , par la suite aligner le plateau.

A

